

# Time Relays

MCB - SER - ERTC - SSR - DG Series



SER-Y/U

DG-60

MCB-20

MCB-9

ERTC-01

## PRODUCT SELECTION TABLE

Product Code	Time	ON Delay (Er)	OFF Delay (Em)	OFF Delay with Control Input (R)	ON Delay with Control Input (Es)	Single shot leading edge (Ts) with control input	Single shot trailing edge (Ta) with control input	Symmetric Flasher (Ef)	Control Input	ON Flasher	OFF Flasher	Down-timer	Star-Delta	Left-Right	No Voltage, Delayed Impulse	24 VAC / DC	230 VAC	12 ~240 VAC / DC	24 ~240 VAC / DC	Pcs / Box
ERT-01	Multi-function T. Relay	1 s - 100 Hours	●	●	●	●			●	●	●	●					●			16
ERTC-01	Multi-function T. Relay	1 s - 100 Hours	●	●	●	●			●	●	●	●					●			16
MCB-7	Time Relay	0,1 s - 30 Hours	●	●												●	●			10
MCB-8	Time Relay	0,1 s - 999 min	●	●												●	●			10
MCB-9	Time Relay	0,1 s - 60 Hours	●	●					●	●						●	●			10
MCB-15	Multi-function T. Relay	0,05 s - 100 Hours	●	●	●			●	●										●	10
MCB-20	Multi-function T. Relay	0,1 s - 100 Hours	●	●	●	●	●	●	●									●		10
MCB-30	Time Relay	2-30 s	●													●	●			10
MCB-60	Time Relay	4-60 s	●													●	●			10
SER-YU	Star - Delta Relay	(λ/U) 20-500 ms (λ) 1-60 s											●			●	●			10
SSR-2X	Right - Left Relay	0,1 s - 60 Hours												●			●			24
DG-10	Time Relay	0,6 s - 10 min													●		●			10
DG-60	Time Relay	0,1 s - 60 min													●		●			10
EF-10	Flasher Relay	1 - 10 s / 0,5 s							●							●	●			10
EF-10T	Flasher Relay	1 - 10 s / 0,5 s							●							●	●			10
ERB-50	Dishwasher Relay	Washing 30, 60, 90,120,180 s, Waiting 3 s, Rinsing 1-30 s															●			20

## SPECIFICATIONS

	MCB-15	MCB-20	EF-10	MCB-7/8/9	MCB-30	MCB-60	SSR-2X	ERB-50	ERT-01	ERTC-01	SER-Y/U	DG-10/60	EF-10T
<b>ENCLOSURE</b>													
Dimensions	PK27		PK22				PK15	PK21	PK20		PK28		PK10
Protection Class	IP40		IP20				IP40-IP20		IP20		IP20		
Weight	0,1kg/pcs				0,1kg/pcs	0,3kg/pcs	0,25kg/pcs	0,1kg/pcs	0,3kg/pcs				
<b>SUPPLY</b>													
Operating Voltage	24-240 VAC/DC	12-240 VAC/DC	230 VAC 24 VAC/DC		230 VAC		230 VAC	230 VAC 110 VAC	230 VAC 24 VAC/DC	230 VAC			
Operating Range	for Un±20%(AC) ; for Un±10%(DC)												
Power Consumption	< 4 VA		< 8 VA				< 4 VA	< 3 VA	< 8 VA	< 3 VA			
<b>OUTPUT</b>													
Repeat Accuracy	±5ms.		±0.1%										
Reset Time	100 ms.		< 150 ms.			100 ms.	80 ms.		120 ms.	-			
Output Contact	1 CO; 8A, 2000 VA, cosφ=1					2 CO; 8A, 2000VA, cosφ=1		1 CO; 8A, 2000VA, cosφ=1		2 NO; 5A,1250VA		1 CO; 16A,4000VA	Triyac; 8A,600VA
<b>AMBIENT CONDITIONS</b>													
Ambient Temperature; Humidity	-5 / +55°C ; 85%												
<b>CONNECTIONS</b>													
Mounting	Rail Mounting, terminals with screw												
Connection Types	Single phase 2 wires												



# Time Relays

MCB - SER - ERTC - SSR - DG Series

## Functions of MCB-15 and MCB-20 (12~240 VAC/DC)

### Single shot leading edge voltage controlled input (Em) [MCB-20] :



### ON Delay (Er) [MCB-15 & MCB-20] :

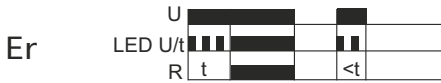

### OFF Delay with control input (R) [MCB-15 & MCB-20] :

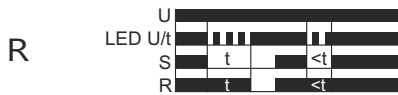

### ON Delay with control input (Es) [MCB-20] :

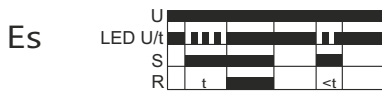

### Single shot leading edge with control input (Ts) [MCB-20] :

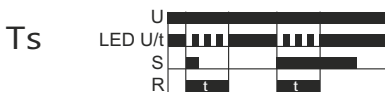

### Single shot trailing edge with control input (Ta) [MCB-20] :

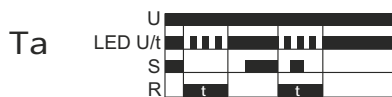

### Flasher (Ef) [MCB-15 & MCB-20] :

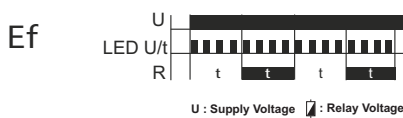

## Common Functions of MCB-7/8/9; ERTC-01; EF-10/10T

### On Delay (Er)

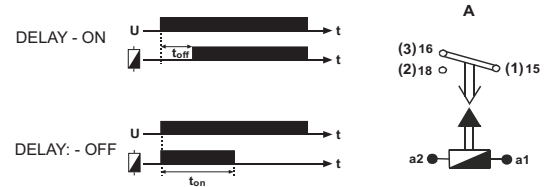

### Flasher

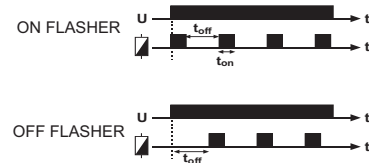

## Functions of SSR-2x

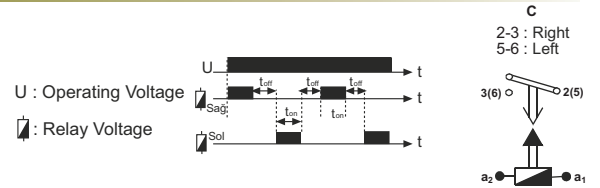

## Functions of DG-06 / DG-10 / DG-60

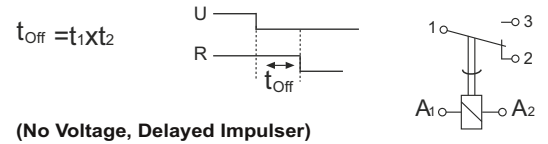

## Washing Machine Relay (ERB-30/50)

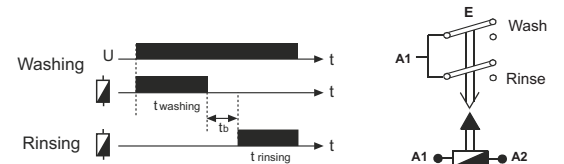

## Functions of SER-Y/U

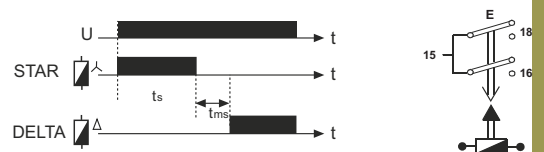

\* 24 VAC/DC supply of SER - Y/U is applied between A2-A3



# Time Relays

MCB - SER - ERTC - SSR - DG Series

## Connection Diagrams

ERB-50

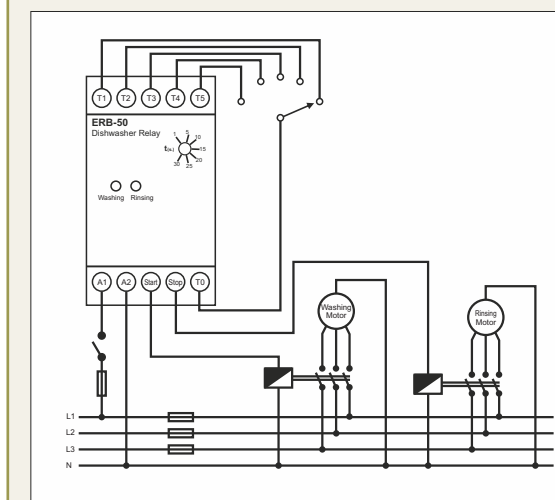

Dimensions

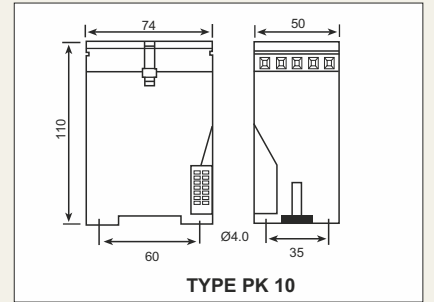

TYPE PK 10

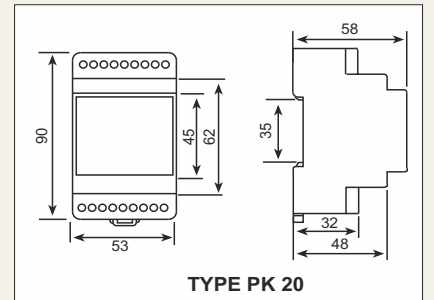

TYPE PK 20

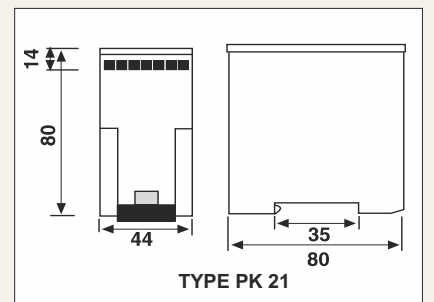

TYPE PK 21

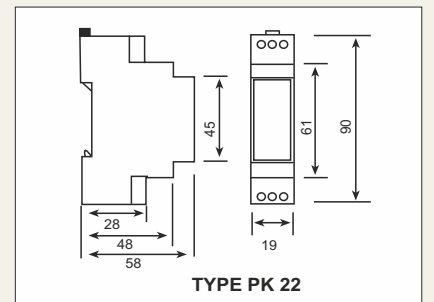

TYPE PK 22

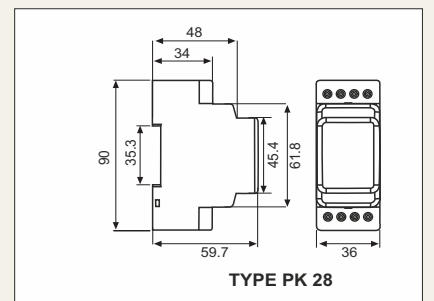

TYPE PK 28

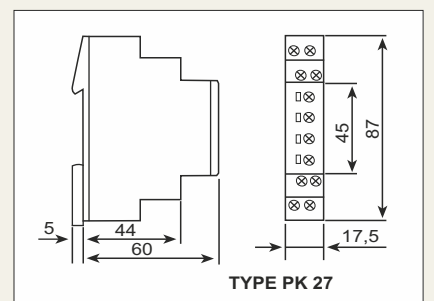

TYPE PK 27

ERTC-01

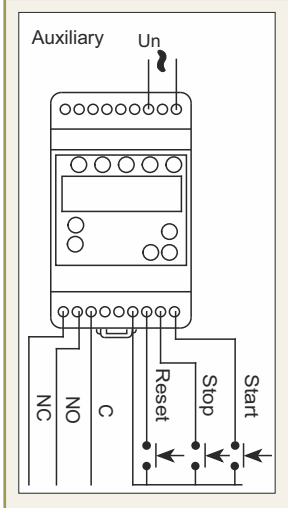

MCB-20

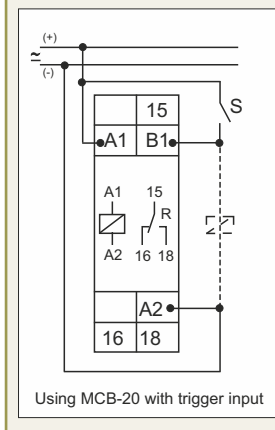

MCB-15

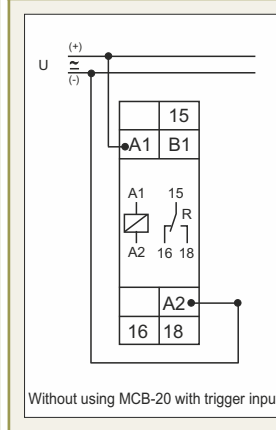

SSRC-04

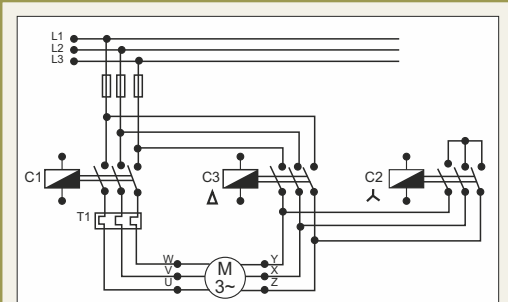

DG Series

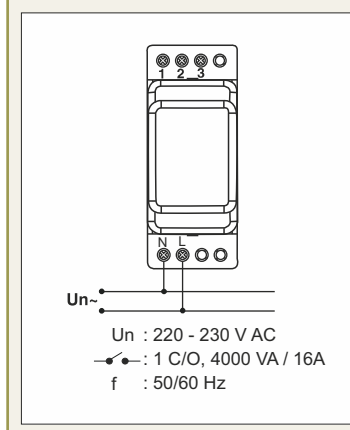

MCB 7-8-9

